

Since 1968

COMMAX
SmartHome & Security

User Manual

Color Video Door Phone CDV-43Y



www.commax.com

COMMAX Co.,Ltd.



- Thank you for purchasing COMMAX products.
- Please carefully read this User's Guide (in particular, precautions for safety) before using a product and follow instructions to use a product exactly.
- The company is not responsible for any safety accidents caused by abnormal operation of the product.

Greetings



- Thank you for choosing COMMAX.
- Please read this manual carefully before you use the product.







Table of contents

Greetings	2
1. Warnings and caution	2
2. Parts Names	4
3. How to use this product	5
4. Monitoring	6
5. Settings	6
6. RESET	8
7. Installation	8
8. Wiring	9
9. Package Contents	11
10. Specification	11

1. Warnings and caution

Please follow the things described below in order to prevent any danger or property damage.

	Warning	It may cause a serious damage or injury if violated.
	Caution	It may cause a minor damage or injury if violated.

	Prohibition.
	No disassembly
	No touch
	Must follow strictly.
	Shows plugging out the power cord without an exception
	Shows the warning and caution for an electric shock.
	Shows the warning and caution for a fire.

! Warning & Caution

Cleaning & Use

Please don't disassemble, repair or rebuild this product arbitrarily (please contact the service center if a repair is needed).

- It may cause an electric shock or fire.



If an abnormal sound, burning smell or smoke is coming out of the product, please plug out the power cable and contact a service center.

- It may cause an electric shock or fire.



Please don't insert any metallic or burnable materials into the ventilation hole.

- It may cause an electric shock or fire.



When cleaning the product, please rub it with a soft and dry cloth after plugging out the power cable. (Please don't use any chemical products such as wax, benzene, alcohol or cleanser.)



! Warning & Caution

Power & Installation

Please don't use several products at the same time on one power socket.

- It may cause a fire due to an abnormal overheating.



Please don't bend the power cable excessively or it may cause an electric shock.

- fire when using a damaged power cable.

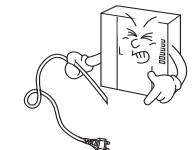

Please don't handle the power cable with a wet hand.

- It may cause an electric shock.

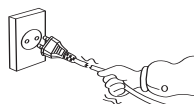

Please plug out the power cable from the socket when not using it for a long period of time.

- It may shorten the product lifespan or cause a fire.



Please don't install the product in the place where there is much oil, smoke or humidity.

- It may cause an electric shock or fire.

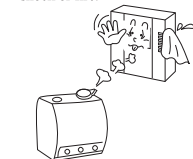

Please don't install the product with the lightning and thunder.

- It may cause an electric shock or fire.

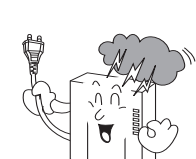

Please don't use and connect this product with other products with different rated voltage.

- It may cause a disorder or fire.

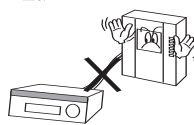

When installing the product that generates heat, please install the product away from the wall (10cm) for the ventilation.

- It may cause a fire due to the increased internal temperature.

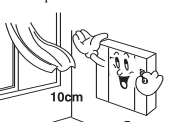



2. Parts Names

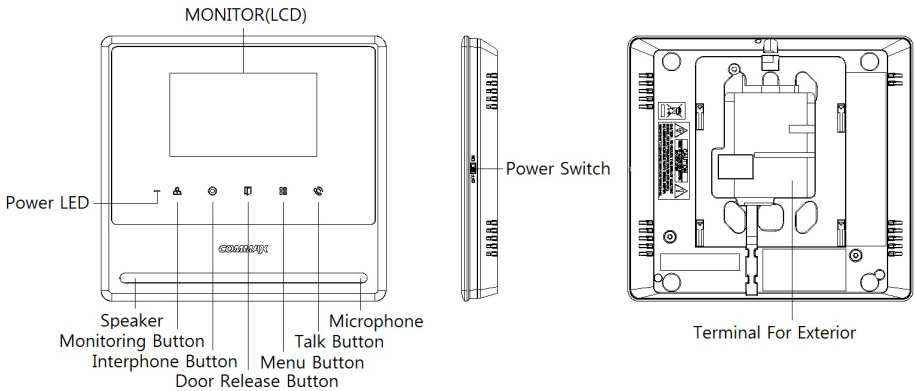

No.	PART		PART	No.	PART
1	POWER SWITCH	5	MONITOR BUTTON / DOWN BUTTON	9	TALK BUTTON
2	POWER LED	6	INTERPHONE BUTTON / SELECT BUTTON	10	SPEAKER
3	MICROPHONE	7	DOOR RELEASE BUTTON / UP BUTTON	11	TERMINAL FOR EXTERIOR
4	MONITOR(LCD)	8	MENU BUTTON		

1. POWER SWITCH

2. **POWER LED** : show blue light when the monitor is turned on, no light when off

3. MICROPHONE

4. MONITOR(LCD)

5. **MONITOR BUTTON (DOWN BUTTON)** : Press to see images from camera. And press to move (down / left) on menu.

6. **INTERPHONE BUTTON (SELECT BUTTON)** : Press to call interphone. And press to select on menu.

7. **DOOR RELEASE BUTTON (UP BUTTON)** : Press to open the door. And press to move (up / right) on menu.

8. **MENU BUTTON** : Press to enter Menu for display adjustment, calling sound setting, product Information etc.

9. **TALK BUTTON** : to call and answer for visitor.

10. SPEAKER

11. **TERMINAL FOR EXTERIOR** : terminal for product upgrade, entrance camera and interphone connection.



3. How to use this product

1. Call from the visitor

- ① When the visitor calls from the entrance(door camera), the calling sound rings and the image of the visitor is shown on LCD screen.
- ② If you press the talk button, you can talk with door camera. By pressing the door release button, door will be released. (Door release works only while talking.)
- ③ 3-way communication is possible when another user picks up the handset of extended interphone, when you are talking with door camera on video door phone.
(3-way : Entrance-Household -Interphone simultaneous communication mode)
- ④ While you are talking with the door camera if you press the talk button, talking is finished and the video door phone turns to stand-by mode.

2. Call with additional interphone

2-1. Call between door camera and interphone

- ① When the visitor calls from the door camera, calling sound rings on interphone and video door phone.
- ② By picking up the handset of interphone, you can talk with door camera. By pressing the door release button, door will be released.

2-2. Talk between interphone and video door phone (household).

2-2-1. In case of receiving the call of household phone from interphone

- (1) In order to call the household from interphone, pick up the interphone handset and press the call button. Then, video phone will be ringing.
- (2) You can talk with interphone by pressing the talk button of household.
- (3) 3-way communication is possible among household, interphone and door camera when visitor calls from door camera, while household is talking with interphone. Image from door camera is displayed on LCD of household with calling sound and 3-way communication gets available.
- (4) Press the talk button after ending the call.

2-2-2. In case of calling interphone from household

- (1) Press the Talk Button and the Interphone Button in order to call the interphone from the Monitor (Interphone is called only while the interphone button on household is being pressed.)
- (2) When you receive the call from interphone, enjoy the call.



4. Monitoring : function to see the image of visitor in the entrance.

(stand-by mode) Operation

- By pressing the MONITOR button repeatedly, the monitor will work as following in order.

Camera1 → Camera2 → OFF



5. Settings

- * Product settings need the following 4 buttons on the product.
- * Start Menu / Exit : MENU button
- * Select and in-put : SELECT button (INTERPHONE button)
- * Move up / Move right: UP button (DOOR RELEASE button)
- * Move down / Move left: DOWN button (MONITOR button)

You can adjust DOOR VIDEO SET, UTILITY and check INFORMATION (model name & version) with (UP) / (DOWN) button after pressing MENU button on the right of the product in video talk mode or stand-by mode.

5-1. Screen setting (Brightness/Contrast/Color adjustment function)

Press the MENU button and access to DOOR VIDEO SET and enter the setting menu by pressing the SELECT button.

- (1) BRIGHTNESS: Adjusting Brightness of Screen.
- (2) CONTRAST: Adjusting Contrast of Screen.
- (3) COLOR: Adjusting Color of Screen.

* How to adjust

- ① Move to Menu you want to adjust with UP/DOWN button on the list of DOOR VIDEO SET
- ② Press the SELECT button to choose an icon.
- ③ Adjust the set value with UP/DOWN button
- ④ Press the select button, To complete.

(4) RESET : Initializing

* How to adjust

- ① Move to RESET menu in DOOR VIDEO SET menu.
- ② Press the SELECT button to enter the menu.
- ③ Select YES with UP/DOWN button.
- ④ Press the SELECT button.

(5) EXIT : Go back to setting mode

5-2. UTILITY(additional function)

Press the MENU button and access to UTILITY and enter the menu by pressing the SELECT button.

(1) SPEAKER-VOLUME: setting receiver sound level while you are talking to the door camera.

* How to adjust

- ① Move to SPEAKER-VOLUME icon with UP /DOWN button in UTILITY Menu.
- ② Press the SELECT button to enter the menu.
- ③ Adjusting receiver level : 1 ~ 3
- ④ To complete the set, Press the SELECT button.

(2) CHIME-BELL VOLUME : setting call sound level.

* How to adjust (You can only adjust during a call)

- ① Move to CHIME-BELL VOLUME icon with UP /DOWN button in UTILITY Menu.
- ② Press SELECT to enter the menu.
- ③ Adjusting call level : 0(MUTE) ~ 3(MAX)
- ④ Press the SLECT button to complete the set.

(3) SCREEN MODE : to set for screen ratio.

* How to adjust

- ① Access to SCREEN MODE with UP /DOWN button in UTILITY Menu.
- ② Press the SELECT button to enter the menu.
- ③ Adjust screen ratio value with UP/DOWN button.
- ④ To complete the set, Press the SELECT button.

- ZOOM : Zoon in(expansion) image maintaining actual ratio(4:3) is shown. (full of the screen).

- 4:3 : Image of 4:3 ratio without expansion is shown.(This is actual ratio for camera).

- WIDE: Full of the screen. Not actual ratio (4:3).

Image is expanded according to LCD (WIDE LCD) ratio.(16:9)

(4) EXIT: Go back to the UTILITY Setting menu.

5-3. INFORMATION (The function to check Model name & Version)

In order to check the product information, Press the menu button and move to INFORMATION menu with UP/DOWN button.

(1) MODEL : You can check the model name.

(2) VERSION : You can check the model version.

(3) SYSTEM : SINGLE (FINE VIEW VIDEOPHONE)

(4) TOUCH : You can check the touch-key version.

(5) VIDEO : You can check the video transmission formats(NTSC/PAL)

(6) SOURCE : You can check the position of camera(DOOR1 / DOOR2) which is shown on the screen for now.

5-4. EXIT (Finish setting menu)

6. RESET : Initializing

Keep pushing interphone and door release button for 3 seconds. (Screen setting and Call volume will be initialized).

Caution : If initialization is activated, all data including screen setting and Call volume will be initialized .

(Screen setting and Call volume)

7. Installation

1. Installation Method of camera monitor

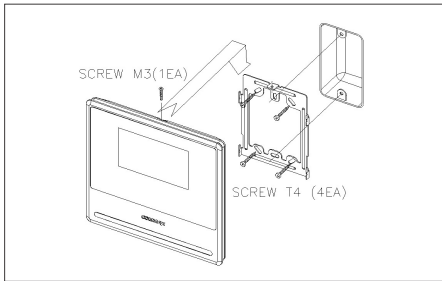

Note

- ① Avoid the range of direct sunlight
- ② Recommended height is pertinent from 1450 ~ 1500mm
- ③ Avoid the installation near magnetic activity, humid temperatures and gas

2. Installation Method of camera

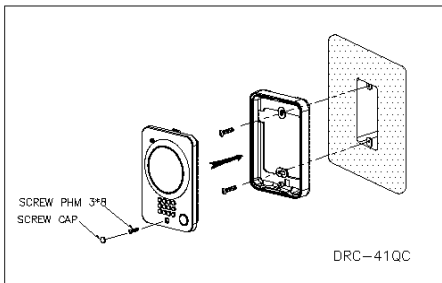

Note

- ① Do not install the camera where it is exposed to Direct sunlight
- ② Keep cleaning up its lens to capture good views.



8. Wiring

The wiring of this equipment is as follows.

*** Camera connector polarity**

1. Red : Voice
2. Blue : GND
3. Yellow : Power(+12V)
4. White : Video

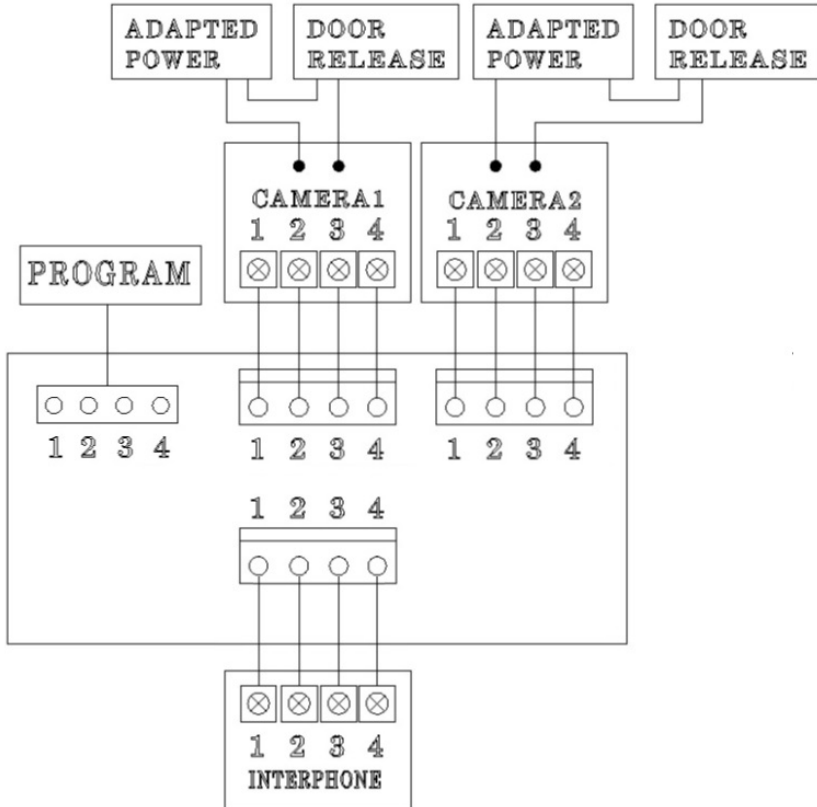

■ Wiring precautions

Each device should be connected by separated cables.

If you use UTP CABLE[CAT.5] for Door and Interphone, 2 lines of UTP cable are required.

■ DOOR Camera Wiring

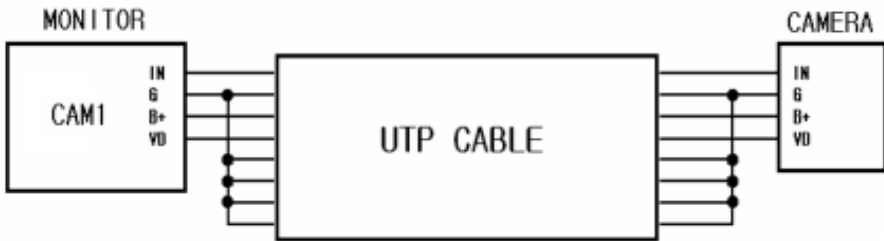

If you use UTP CABLE[CAT.5], Connect the rest 4 lines to GND after connecting 4 lines between monitor and camera.

■ INTERPHONE Wiring

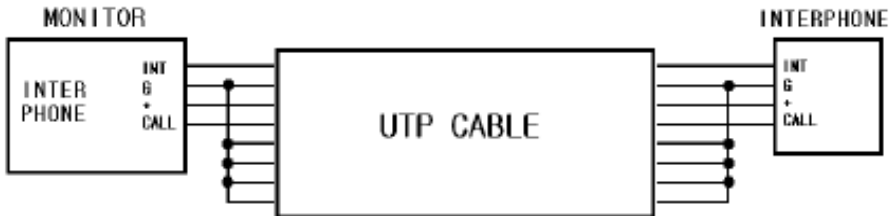

If you use UTP CABLE[CAT.5], connect the rest 4 lines to GND after connecting 4 lines between monitor and interphone.

9. Package Contents

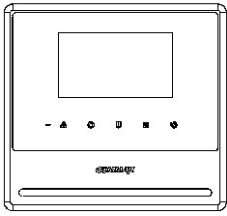

① Body of CDV-43Y

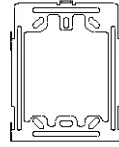

② Bracket for wall mount



③ Manual

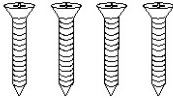

④ T4 X 18(4EA)
Screw for wall mount



⑤ M3 x 6(1EA)
Screw for body

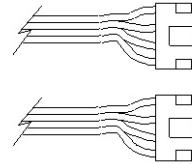

⑥ 4P Connector(2EA)

10. Specification

SPEC	CDV-43Y		
Wiring	Door camera 4wires (Polarity), interphone 4wires (polarity)		
Rating Voltage	100V-240V~, 50/60Hz (FREE VOLTAGE)		
Power consumption	Stand-by : 3W	Maximum: 12 W	
Transmission way	HANDS FREE (Voice switch circuit)		
Screen size	4.3" TFT-DIGITAL LCD		
Ringtone	Door : Electronic chime (Sol Mi Do), Interphone : Beep		
Display	Monitoring : 30 ±5sec		Talk : 60 ±5sec
Distance(Cable thickness)	Pie 0.5mm	0.65mm	0.8mm
	28m	50m	70m
Working temperature	0 ~ +40°C (32°F ~ 104°F)		
Dimension (mm)	171.0(W) X 184.0(H) X 23.2(D)		

COMMAX

COMMAX Co.,Ltd.

513-11, Sangdaewon-dong, Jungwon-gu, Seongnam-si, Gyeonggi-do, Korea

Int'l Business Dept. Tel. : +82-31-7393-540~550 Fax. : +82-31-745-2133

Web site : www.commax.com

Edited.2021.04.09

Printed In Korea / 2021. 04.105